



AquiStar[®] TempHion[™]

Smart Sensor (ph, ISE, Redox/ORP)



True data, measure by measure



Table of Contents

Introduction	3
What is the TempHion™ Smart Sensor?	3
Initial Inspection and Handling	3
Do's and Don'ts	3
TempHion™ Reference Electrode	4
Battery Life Note	5
General Precautions	5
Installation and Operation.....	6
Connecting External Power	6
Connecting the TempHion™ to a Computer.....	6
Installing the Aqua4Plus Software.....	6
Calibration	6
Field Deployment	7
Collecting Data	8
Maintenance	11
Care and Filling of Reference Solution Reservoir.....	11
Storing Sensor.....	13
Changing Batteries.....	13
Appendix A: Technical Specifications	14
Wiring Information	14
Dimensions and Specifications	15
Appendix B: Field Calibration.....	17
Calibration Overview.....	17
Field Calibration Window and Calculator	18
Temperature Channel Calibration.....	18
pH Channel Calibration	18
ISE Channel Calibration	20
Redox (ORP) Channel Calibration	23
Appendix B1: pH Field Calibration Temperature Chart	24
Appendix B2: M & I Range for pH Calibration	24
Appendix C: Elements, Reference Solutions, and Related Settings	25
Appendix D: How to Store and Recondition	26
Storage	26
Reconditioning	26
Appendix E: Alternate Connection Options	27
Connecting via RS232 Serial Port	27
Connecting with a USB/Serial Adapter	27
Appendix F: Reading the TempHion™ via Direct Read.....	29
Setting Units for Direct Read	29
Reading Via Modbus® RTU	30
Reading Via SDI-12.....	32
Appendix G: Battery Changing Details	34
Reordering Information	38
Limited Warranty/Disclaimer - Aquistar® TempHion™ Smart Sensor	39

Information in this document is subject to change without notice and does not represent a commitment on the part of the manufacturer. No part of this manual may be reproduced or transmitted in any form or by any means, electronic or mechanical, including photocopying and recording, for any purpose without the express written permission of the manufacturer.

Introduction

What is the TempHion™ Smart Sensor?

The AquiStar® TempHion™ Smart Sensor is a submersible water quality sensor and datalogger capable of measuring pH, specific ions, redox (ORP), and temperature. Each unit comes with a thermistor based temperature element plus a combination of pH, ISE, or redox (ORP) elements. (Contact INW for available combinations.)

The TempHion™ Smart Sensor is powered internally with two AA alkaline batteries or with an auxiliary 12VDC power supply for data intensive applications. The unit is programmed using a Windows® based computer and INW's easy-to-use Aqua4Plus software. Once programmed, the unit will measure and collect data on a variety of time intervals.

Several TempHions, or a combination of TempHions and other INW Smart Sensors, can be networked together and controlled from one location, either directly from a single computer or via a WaveData® Wireless Data Collection System.

The internal processor in the TempHion™ Smart Sensor allows for easy calibration, using the calibration utilities in Aqua4Plus. Once calibrated, this calibration data is stored in non-volatile memory within the Smart Sensor. When data is collected, this calibration information is applied to the data, resulting in highly accurate readings at a wide range of temperatures.

Initial Inspection and Handling

Upon receipt of your smart sensor, inspect the shipping package for damage. After opening the carton, look for concealed damage, such as a cut cable. If damage is found, immediately file a claim with the carrier. Check the label attached to the cable at the connector end for the proper cable length.

Do's and Don'ts

Do handle the device with care.

Do refer to Appendix D for storage information.

Don't install the device so that the connector end is submerged.

Don't support the device with the connector or with the connectors of an extension cable. Use a strain relief device to take the tension off the connectors.

Don't allow the device to free-fall down a well as impact damage can occur.

Don't bang or drop the device on hard objects.

TempHion™ Reference Electrode

TempHion's patented reference electrode is the key to TempHion's superior downhole/high pressure performance. TempHion uses a long capillary pathway, initially filled with reference electrode filling solution, to separate the reference electrode chamber from the solution being analyzed. In addition, TempHion's reference electrode is filled without *any* air (which is compressible). With this construction, the principle mechanism that will eventually allow test solution to enter the reference chamber and contaminate the reference electrode filling solution is diffusion - an exceedingly slow mechanism. Further, while the capillary pathway is narrow by garden hose standards, its open cross-section is huge compared to the microscopic openings in a conventional porous ceramic fluid/fluid junction. It is therefore much less susceptible to fouling. Fluid expansion and contraction caused by temperature variations can augment the effects of diffusion. Nevertheless, TempHion's proven stability under actual field conditions is measured in weeks or months, rather than hours or days!

The figure below illustrates the construction of the TempHion™ reference electrode. Please note that the capillary pathway between the reference and test solutions is established using a modified screw thread. This means that the capillary can be easily opened up for cleaning, refilling, or other maintenance.

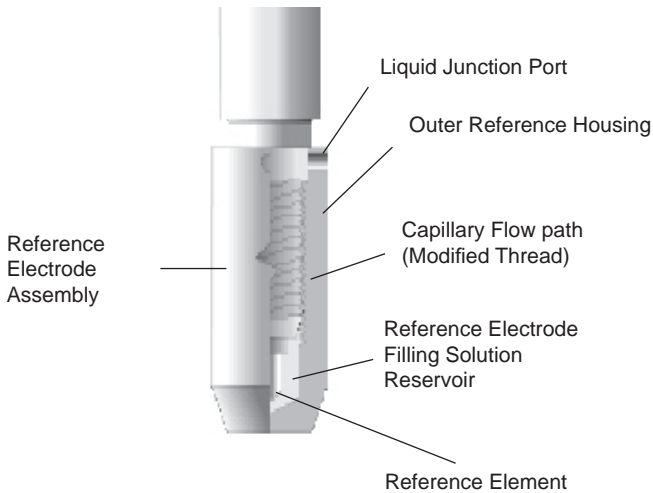

Reference Electrode Assembly: The modified thread provides a continuous liquid path between the solution in which the instrument is immersed and the reference element.

TempHion with standard pH elements, ISE elements, and ORP elements come with the TempHion Reference Electrode, as described above. The TempHion is also sold with a wastewater pH element that has a built in reference and so does not use a filling solution.

Battery Life Note

The TempHion sensors are shipped from the factory with fresh internal AA batteries. These batteries should last several months to a year. Actual battery life may depend on battery brand, battery age, temperature of the environment, usage schedule, and other factors.

General Precautions

The rest of this manual includes step-by-step instructions for setting up the TempHion™, calibrating it, and using it in the field. When reading and following the instructions in these sections, keep these very important considerations in mind:

- Do not handle the surfaces of the sensing electrodes. Oils from fingers can “blind” the reactive surface. Rough handling can scratch the reactive surface.
- Avoid long-term exposure of silver-based sensing electrodes to bright sunlight.
- Use calibration standards that are accurately prepared. Discard standards after use. Do not return the used standards to the bottles of “fresh” solution.
- When TempHion’s reference electrode contains filling solution, The o-ring at the top of the reference assembly must be in the upper position. (See further details under Field Deployment later in this manual.)
- For any step-change in temperature (e.g., where calibration standards are at a different temperature than water to be tested) allow the instrument to come to complete thermal equilibrium before making measurements. Up to 30 minutes may be required.

Installation and Operation

Connecting External Power

The TempHion™ comes with two AA internal batteries. If auxiliary power is desired, you can use a 6 - 13 VDC supply that can provide 15 mA. Connect to Vaux++ (white) and Ground (blue) or contact INW for auxiliary power connectors.

Connecting the TempHion™ to a Computer

In its cabled configuration, the TempHion™ cable is terminated with a weather-resistant connector. In its cableless configuration, the TempHion™ is terminated with a weather-resistant connector inside a screw-cap. Connect the weather-resistant connector to your computer's USB port as shown below. (For alternate connection options, see Appendix E.)

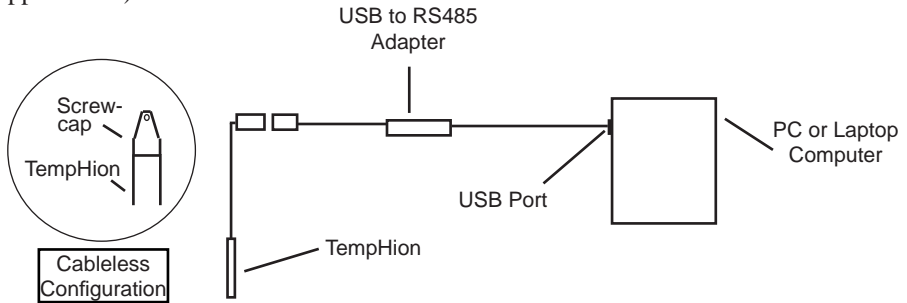

*Connect the TempHion™ to your PC using a USB to RS485 adapter.
(See Appendix E for alternate connection options.)*

Installing the Aqua4Plus Software

The TempHion™ comes with the Aqua4Plus host software to be installed on your PC or laptop. Use this software to calibrate the sensor, to program the datalogger, to retrieve data from the logger, to view collected data, and to export data to external files for use with spreadsheets or databases. Refer to the Aqua4Plus software manual for details on installing and using Aqua4Plus.

Calibration

The TempHion has one temperature channel and four millivolt channels. The millivolt channels can be configured to measure pH, redox, or various selected ions. Before leaving the factory, your sensor has been configured specifically for you. All unneeded channels have been disabled, and the active channels have been pre-configured. Disabled channels will not display in Aqua4Plus.

(Note: Some older TempHions may have more channels. If yours has more channels, refer to the documentation that came with the unit or contact INW for more information.)

All active channels can be calibrated in the field. Temperature channels rarely need calibrating, however the millivolt channels should be calibrated before first use and periodically thereafter.

Environmental conditions of turbulence and temperature swings, as well as local likelihood for bio-fouling or mineral deposition, can vary considerably from site to site. Therefore, where the sensor is to be used for long-term monitoring, it is recommended that the calibration be initially checked frequently until a performance history is established.

See Appendix B for detailed calibration instructions.

Field Deployment

The black reference reservoir at the lower end of the TempHion™ Smart Sensor is shipped filled with INW reference solution. (If your reference reservoir is not filled, see the Maintenance section in this manual.) The black reference assembly has two grooves. The upper groove contains a small hole that forms the liquid junction port. During shipping and storage, an o-ring is located in the upper groove, preventing reference solution leakage and contamination. Be sure to move the o-ring to the lower groove before deploying, thus exposing the liquid junction port. If the o-ring continues to cover the opening, readings will not be representative or accurate.



Be sure to move the o-ring to the lower groove before deploying, thus exposing the liquid junction port.

(If you have the wastewater pH element, disregard the previous paragraph.)

Lower the sensor to the desired depth. Fasten the cable to the well head using tie wraps or a weather proof strain-relief system. (Note that for shallow installations the liquid in which the sensor is submerged must, at all times, reach high enough to touch the metal tubing on the sensor.)

Be sure the supplied cap is securely placed on the weather-resistant connector at the top of the cable. Do not install such that the connector might become submerged with changing weather conditions. The connector can withstand incidental splashing but is not designed to be submerged.

Collecting Data

Following is a brief overview on using Aqua4Plus to collect data. Please refer to the *Aqua4Plus Instruction Manual* for further details on configuring and using Aqua4Plus.

Real Time Monitor

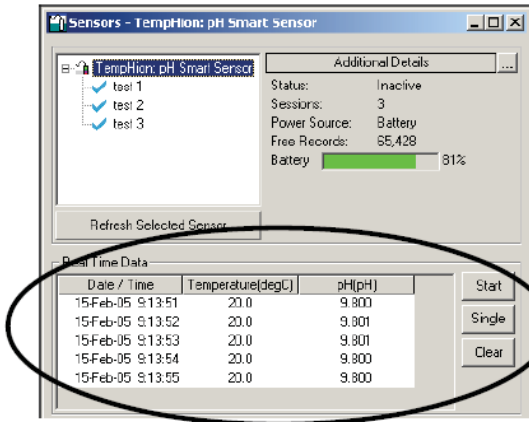

Click Single to get a single reading.

Click Start to get a reading once a second.

Click Stop to stop the reading.

Note: These are snapshot readings and are not recorded on the sensor.

The Real Time Monitor gives a snapshot of the current readings on the sensor.

Setting up a Data Recording Session

Click the  tool button. A Session Profile Window will open. Refer to the *Aqua4Plus Instruction Manual* for details in describing your session profile. Click the Start button to save the session to the sensor and begin recording.

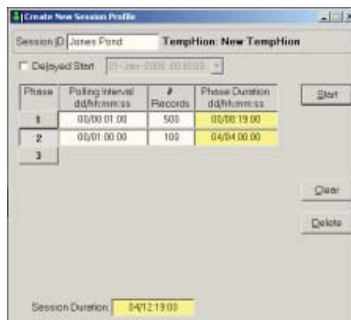

Using the Session Profile Window, describe the test steps for your particular test.

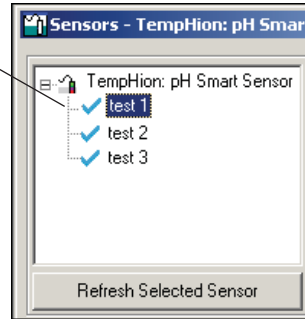

Retrieving Data from the Sensor/Datalogger

- Click on the session you want to upload.
- Click the  tool button.
- Select a file location.
- Click Save.
- Click Start.



Select the data session you are ready to upload.

Viewing Data

- Click the  tool button to view data as a table.
- Click the  tool button to view data as a graph.
- Navigate to the desired file, then click the Open button. (If the File Open box does not appear, click the File Menu, then select Open.)

Sensor SN	Sensor Type	Sensor Name	Session Name
2452034	TempHion	pH Smart Sensor	Test 25A

	Temperature(degC)	pH(pH)
Sensor Range	-40 - +125 degC	0-14 pH
Minimum	22.0	6.986
Maximum	28.4	7.019
Mean	27.0	6.992
Variance	4.02	0.0001
Std Deviation	2.00	0.0091
Element	30K type 5 thermistor	
Cal Date	7-Feb-05	7-Feb-05

Rec#	Date/Time	Temperature(degC)	pH(pH)
1	07-Feb-05 13:13:03	22.0	7.018
2	07-Feb-05 13:14:03	22.0	7.018
3	07-Feb-05 13:15:03	22.0	7.019
4	07-Feb-05 13:16:03	22.2	7.016
5	07-Feb-05 13:17:03	22.7	7.013
6	07-Feb-05 13:18:03	23.3	7.005
7	07-Feb-05 13:19:03	24.0	7.002
8	07-Feb-05 13:20:03	24.6	6.998
9	07-Feb-05 13:21:03	25.2	6.996
10	07-Feb-05 13:22:03	25.7	6.993

The File Display Window displays your data in a tabular format.

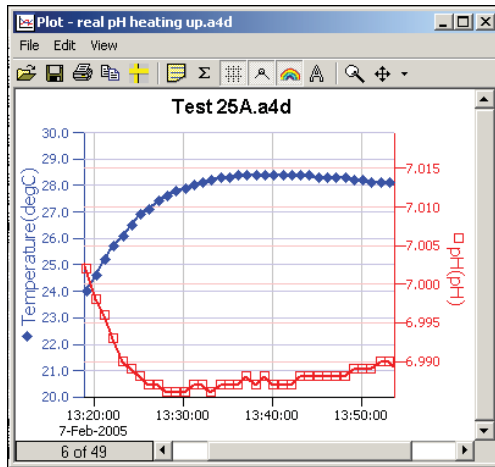

The Graph Window displays your data on an X Y coordinate graph.

Exporting Data to .csv or .xls Files

- Using the File Display window, open the file you want to export.
- Click on the  tool button.
- Select a file location and enter a name for the file.
- Select a file type.
- Click Save.

A Word About Units

Readings from the TempHion™ Smart Sensor can be displayed in various units. Select the units you want from the Options | Units menu.

pH:	pH or mV
ISE:	ppm or mV
Redox:	Eh or mV
Temperature:	Degrees Celsius, Fahrenheit, or Kelvin

When using pH, ppm, or Eh units, all readings are automatically compensated for temperature and all field calibration factors are applied. When using millivolts or ohms, only the actual millivolt or resistance values are displayed - no adjustments are made.

Maintenance

Care and Filling of Reference Solution Reservoir

(Note: See Appendix C for correct filling solution for your unit. Disregard if using the wastewater pH element.)

The TempHion's patented reference electrode is key to the TempHion's superior performance. The TempHion uses a long capillary pathway, filled with reference solution, to separate the reference electrode from the solution being analyzed. Proper care and filling of this reference solution reservoir is essential to accurate functioning of the sensor.

Your TempHion is normally shipped from the factory already filled with reference solution. However, from time to time you will need to replace the reference solution. If you notice you are getting erratic readings, this is an indication that the filling solution may need to be replaced. We also recommend replacing the filling solution when doing periodic calibrations.

The TempHion is normally shipped with a bottle of INW Reference Solution. If you will be using a different solution, contact INW for any adjustments that may be needed.

Emptying and Cleaning the Reservoir

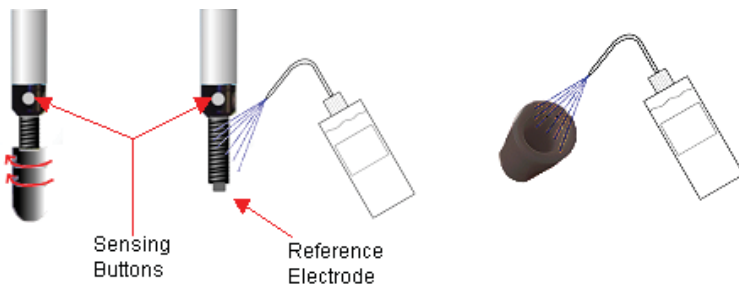

Rinse the reference electrode and the inside of the cap with distilled or de-ionized water.

- Unscrew the reservoir cap. **Do not touch or scratch the sensing buttons or the reference electrode!**
- Empty any remaining filling solution from the cap.
- Thoroughly rinse the reference electrode and the inside of the cap with distilled or de-ionized water.
- There may be some crystallized residue inside the cap, on the electrode screw path, or on the electrode itself. If rinsing does not clear this away, then gently use a cotton swab or a soft toothbrush to remove the residue.
- Rinse the electrode assembly and cap thoroughly again after cleaning with the swab or brush.
- Gently, pat dry with a clean paper towel.

Filling the Reservoir

Once the reservoir has been emptied and cleaned, you are ready to fill the reservoir with reference solution.

- Rinse the reference electrode assembly and the inside of the cap with a small amount of the reference solution.
- Empty any remaining solution from the cap.
- Fill cap about half full with reference solution.
- Holding sensor vertically, replace reservoir cap. Some solution should spill from the top as you screw the cap on. This assures that no air bubbles are trapped inside.

If any air bubbles are trapped, a proper electrical connection cannot be made and the sensor may read erratically!

Excess filling solution spills over, forcing out any air bubbles.



CAUTION: Filling solutions are not considered hazardous, but they can be irritating to the skin. Protective gloves are advised. Rinse hands or gloves with fresh water.

- Once filled, be sure the o-ring is in the upper groove to prevent reference solution leakage and contamination. **Before deploying be sure to move the o-ring to the lower groove to expose the liquid junction port.**



Be sure to move the o-ring to the lower groove before deploying, thus exposing the liquid junction port.

Storing Sensor

Refer to Appendix D for information on storage.

Changing Batteries

Battery Type: Two standard AA Alkaline batteries.

Because changing the batteries involves opening the water-tight seal, **this must be done in a clean, dry environment to avoid contamination or moisture damage to the circuitry.**

Refer to Appendix G for details on changing batteries.

Appendix A: Technical Specifications

Wiring Information

Cable Type: 9-conductor, shielded

Shield	=	Ground
White	=	Vaux (6 to 13 VDC)
Brown	=	SDI-12
Orange	=	Vbat+ (1.8 to 3.3 VDC)
Blue	=	Ground
Yellow	=	Comm D+
Purple	=	Comm D-

For Modbus® —
with 5-pin connector

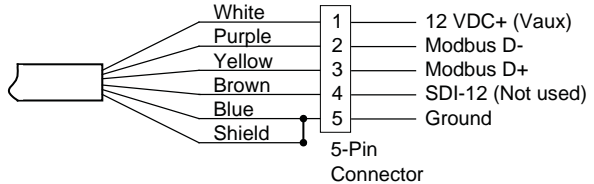

For SDI-12 —
with 5-pin connector

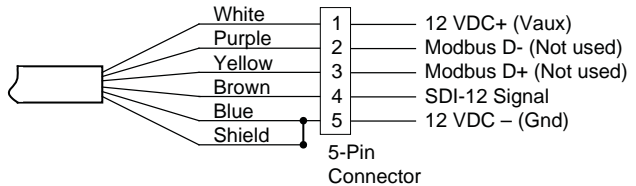

For SDI-12 —
without connector

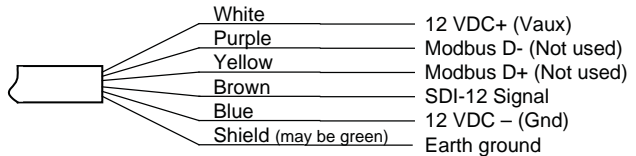

Dimensions and Specifications

SENSOR

Length

w/batteries	17.96" (45.6 cm)
w/o batteries	14.16" (36.0 cm)
	<i>Cableless 0.25" (0.6 cm) shorter</i>

Diameter

0.75" (1.9 cm)

Weight

0.85 lb (0.4 kg)

Body Materials

Acetal & 316 stainless steel or titanium

Wire Seal Materials

Fluoropolymer and PTFE

Submersible Cable

Polyurethane, polyethylene, FEP or ETFE

Cable Weight

4 lbs/100 ft (1.8 kg/30 m)

Communication

RS485 Modbus®

Available Channels

Temperature, pH and ORP

Temperature, ISE

Operating Temperature Range

0° C to 50° C

Storage Temperature Range¹

-20° C to 80° C

Reference

<i>Electrode</i>	Ag/AgCl solid-state electrode
<i>Junction</i>	Patented capillary liquid junction
<i>Electrolyte</i>	TempHion™ reference solution

Maximum Depth

pH/ORP: 700 ft. (210 m), 300psi
ISE: 230 ft. (70 m), 100 psi

LOGGING

Memory

4MB - 400,000 records

Logging Rate

2x/sec

Resolution

16 bit

File Formats

.xls / .csv / .a4d

Baud Rates

9600, 19,200, 38,400

POWER

Internal Battery

2x1.5V AA Alkaline²

Auxiliary Power

12 VDC – Nominal
6V-15VDC – Range

TEMPERATURE

Element Type

30K ohm thermistor

Element Material

Epoxy bead/external housing

Accuracy

± 0.5° C

Resolution

0.01° C

Units

Celsius, Fahrenheit, Kelvin

ION SPECIFIC ELECTRODE

Chloride/Bromide

Measurement Principle	Ion electrode method
Probe Material	Ag/AgCl solid-state electrode
Range	0-10,000 ppm
Typical Accuracy	± 5.0% of measured value
Resolution	0.1 ppm
Thermal Compensation	Isopotential point characterization
Calibration	1-2 point method w/ ionic strength adjustment
Reference Solution (Chloride)	ION-Plus B
Reference Solution (Bromide)	Potassium Nitrate - (KNO ₃)

pH/REDOX**Sensor Type/Material**

<i>pH</i>	Glass combination electrode
<i>Redox</i>	Platinum ring

Ranges

<i>pH</i>	0-14 pH units / -538mV to 260mV
<i>Redox</i>	± 1200mV

Units

<i>pH</i>	pH, mV
<i>Redox</i>	Eh (mVH), mV

Typical Accuracy

<i>pH</i>	± 0.2 pH units
<i>Redox</i>	0.1 Eh (mVH)

Resolution

<i>pH</i>	0.01 pH units
<i>Redox</i>	0.01 Eh (mVH)

Calibration

<i>pH</i>	1 and 2 point w/ pH buffers (7 & 4 or 10)
<i>Redox</i>	1 point

Compensated Range

0° C to 40° C

Reference SolutionPotassium Nitrate - (KNO₃)¹ Storage without batteries² Lithium available upon request

Appendix B: Field Calibration

Calibration Overview

The TempHion should be calibrated before first use and periodically thereafter. It should also be calibrated if moving to a different sampling environment where readings will be significantly different than the current environment.

Environmental conditions of turbulence and temperature swings, as well as local likelihood for bio-fouling or mineral deposition, can vary considerably from site to site. Therefore, where the sensor is to be used for long-term monitoring, it is recommended that the calibration be initially checked frequently until a performance history is established.

Aqua4Plus provides an easy-to-use calibration calculator for performing one- or two-point in-field calibrations. Two-point calibrations are more accurate and should be used whenever possible. A Calibration Kit is available from INW, which includes a beaker, pipette, measuring beaker, and stand.



IMPORTANT NOTES

- Filling Solution Reservoir
(Does not apply to wastewater pH element)
 - In order for the TempHion Smart Sensor to calibrate and function correctly, the filling solution reservoir must be properly filled with reference solution. For details, see earlier in this manual.
 - Be sure the o-ring on the black reference housing has been moved to the lower groove, exposing the liquid junction port.
- **The sensor and all calibration buffers and solutions should be at the same temperature before and during calibration.**
- Refer to Appendix D for reconditioning times prior to calibration.
- Calibration can only be done when there are no sessions stored on the sensor. If there are any sessions stored on the sensor, upload any data you want and then erase the sessions before continuing. (Sessions Menu Erase All Sessions).



IMPORTANT !

If your reference electrode has been stored dry or in KCl solution, you should let it sit at least a half hour after filling with reference solution before using or calibrating.

If your pH sensor has been stored with the bulb dry, you should soak it in your first pH buffer for about four hours to recondition the bulb before calibrating. This applies to the wastewater element, also, if it has been stored dry.

If your chloride or bromide sensor has been stored with the element dry, you should soak it in your first calibration solution for at least a half hour before using or calibrating.

See Appendix D for more information on storage and reconditioning.

Field Calibration Window and Calculator

Field calibration is performed on each channel separately. To calibrate a specific channel, select Field Calibration from the Configure Menu, and then click on the channel to be calibrated. Follow directions below for each specific channel type.

Calculator		First Point	Second Point	Cal Values
Ref ppm	<input type="text"/>	<input type="text"/>	<input type="text"/>	M: <input type="text"/>
mV	<input type="text"/>	<input type="text"/>	<input type="text"/>	I: <input type="text"/>
	<input type="button" value="Measure"/>	<input type="button" value="Measure"/>		<input type="button" value="Apply"/>

Use the Aqua4Plus calibration calculator to perform one- and two-point calibrations.

Temperature Channel Calibration

The temperature channel rarely needs calibration. If needed, select Field Calibration from the Configure Menu. Click on Temperature, and then follow the instructions on the screen.

pH Channel Calibration

Preparing

- INW recommends pH buffers of 4, 7, and 10 for calibration. For a one-point calibration, select the buffer closest to the expected values in your samples. For a two-point calibration, select the two buffers that most closely bracket the expected values in your samples.
- Before calibrating, check the chart in Appendix B2 for the range of M and I values you can expect to obtain during calibration.



IMPORTANT !

The pH of any buffer varies slightly with temperature change. For this reason, it is important that you determine the current pH value of the buffer you are using. Refer to Appendix B1 for a pH Buffer / Temperature chart. From this chart, determine the pH value at your current buffer temperature and use this value as the “Ref pH” value in the calibration instructions below. For example, if you are using a pH buffer of 7 and your buffer temperature is 20 degrees C, then you would enter 7.02 in the Ref pH box.

One-Point Calibration

— First Calibration Point —

- Prepare the buffer.
- Rinse sensor first with distilled water and then with small amount of the buffer.
- Place sensor in buffer. (Buffer must be deep enough to cover the sensing bulb in the slot in the black module on the sensor.)
- Allow time for sensor to stabilize.
- In the *Ref pH* box for the first point, enter the temperature adjusted reference pH as noted in the preparation section above.
- Click first *Measure* button.
- When readings have stabilized to your satisfaction, click the *OK* button in the pop-up box.

— Applying Calibration Values —

- Observe the *I* value in the right hand section of the calculator. This should be between the *I* values shown in the chart in Appendix B2.
- Click the *Apply* button to apply calibration values.
- The reference value, the computed I, and the sample temperature will be transferred to the calibration fields.
- Click *OK* to save the values to the sensor.

— Verifying Calibration Values —

- Using the Real Time Monitor, take a few readings while the sensor is still in the buffer. Be sure units are set to pH. Readings should be very close to your selected buffer.

Two-Point Calibration

— First Calibration Point —

- Prepare first buffer.
- Rinse sensor first with distilled water and then with small amount of first buffer.
- Place sensor in buffer. (Buffer must be deep enough to cover the sensing bulb in the slot in the black module on the sensor.)
- Allow time for sensor to stabilize.
- In the *Ref pH* box for the first point, enter the temperature adjusted reference pH as noted in the preparation section above.
- Click first *Measure* button.
- When readings have stabilized to your satisfaction, click the *OK* button in the pop-up box.

— Second Calibration Point —

- Prepare the second buffer.
- Rinse sensor first with distilled water and then with small amount of second buffer.
- Place sensor in second buffer. (Buffer must be deep enough to contact stainless steel tube above the sensor section.)

- In the **Ref pH** box for the second point, enter the temperature adjusted reference pH as noted in the preparation section above.
- Click second **Measure** button. (Note: measured temperature must be +/- 1 degree of first measured temperature or calibration will not be accurate!)
- When readings have stabilized to your satisfaction, click the **OK** button in the pop-up box.

— **Applying Calibration Values** —

- Observe the **M** and **I** values in the right hand section of the calculator. These should be between the **M** and **I** values shown in the chart in Appendix B2.
- Click the **Apply** button to apply calibration values.
- The reference values, the computed M and I, and the sample temperature will be transferred to the calibration fields.
- Click **OK** to save the values to the sensor.

— **Verifying Calibration Values** —

- Using the Real Time Monitor, take a few readings while the sensor is still in the buffer. Be sure units are set to pH. Readings should be very close to your selected buffer.

ISE Channel Calibration

Introduction to ISE Calibration

INW recommends using the “known addition method” for preparing calibration solutions. Using this method, the sensor is placed in 100 mL of distilled or de-ionized water. A small amount of standard is added to create a known concentration. The first point is measured. An additional amount of the same standard is added to create a second known concentration. The second point is measured.

INW recommends the calibration standards listed below. The following instructions are based on using one of these standards. If you use different standards or prefer not to use the known addition method, you must use some other method to determine the concentration used for the first and second point when calibrating.

Recommended Standards

Bromide

- 0.1 Molar NaBr (equates to 7990 ppm)

Chloride

- 0.1 Molar NaCl (equates to 3550 ppm)
- 100 ppm
- 1000 ppm

Preparing

- Select a standard that you will be using for calibration.
- Place 100 mL of distilled water in a beaker.

*Note: Temperature of the water **must remain the same** throughout the calibration. Temperature of the sensor must also be this temperature prior to calibration.*

One-Point Calibration

— Computing Calibration Value—

- Rinse sensor with distilled water and pat dry.
- Place sensor in beaker of distilled water, as prepared above. (Solution must be deep enough to cover the sensing buttons.)
- Add 1 cc of selected standard to the water. Depending on which solution you are using, this will result in a concentration as shown below:
 - 0.1 Molar NaBr (Bromide) = 79.10 ppm
 - 0.1 Molar NaCl (Chloride) = 35.15 ppm
 - 100 ppm (Chloride) = 0.99 ppm
 - 1000 ppm (Chloride) = 9.90 ppm
- Stir to distribute standard evenly.
- Allow time for sensor to stabilize (15 - 20 minutes).
- In the **Ref ppm** box for the first point, enter the concentration you have chosen.
- Click the first **Measure** button. (Readings will be in mV).
- When readings have stabilized to your satisfaction, click the **OK** button on the pop-up box.

— Applying Calibration Values—

- Observe the **I** value in the right hand section of the calculator. For Bromide, **I** should be between 0 and 40. For Chloride, **I** should be between 120 and 160.
- Click the **Apply** button to apply calibration values.
- The reference value, the computed I, and the sample temperature will be transferred to the calibration fields.
- Click **OK** to save the values to the sensor.

— Verifying Calibration Values—

- Using the Real Time Monitor, take a few readings while the sensor is still in the standard. Be sure units are set to ppm. Readings should be very close to your selected concentration.

Two-Point Calibration

— First Calibration Point—

- Rinse sensor with distilled water and pat dry.
- Place sensor in beaker of distilled water, as prepared above. (Solution must be deep enough to cover the sensing buttons.)
- Add 1 cc of selected standard to the water. Depending on which solution you are using, this will result in a concentration as shown below:

- 0.1 Molar NaBr (Bromide) = 79.10 ppm
- 0.1 Molar NaCl (Chloride) = 35.15 ppm
- 100 ppm (Chloride) = 0.99 ppm
- 1000 ppm (Chloride) = 9.90 ppm

- Stir to distribute standard evenly.
- Allow time for sensor to stabilize (15 - 20 minutes).
- In the **Ref ppm** box for the first point, enter the concentration you have chosen.
- Click the first **Measure** button.
- When readings have stabilized to your satisfaction, click the **OK** button on the pop-up box.

— Second Calibration Point—

- Add 10 cc of the *same* standard to the water. Depending on which solution you are using, this will result in a concentration as shown below:
 - 0.1 Molar NaBr (Bromide) = 791.8 ppm
 - 0.1 Molar NaCl (Chloride) = 351.8 ppm
 - 100 ppm (Chloride) = 9.9 ppm
 - 1000 ppm (Chloride) = 99.0 ppm
- Stir to distribute standard evenly.
- Allow time for sensor to stabilize (15 - 20 minutes).
- In the **Ref ppm** box for the second point, enter the concentration you have chosen.
- Click the second **Measure** button.
- When readings have stabilized to your satisfaction, click the **OK** button on the pop-up box.

— Applying Calibration Values—

- Observe the **M** and **I** values in the right hand section of the calculator. **M** should be between -50 and -60. For Bromide, **I** should be between 0 and 40. For Chloride, **I** should be between 120 and 160.
- Click the **Apply** button to apply calibration values.
- The reference values, the computed M and I, and the sample temperature will be transferred to the calibration fields.
- Click **OK** to save the values to the sensor.

— Verifying Calibration Values—

- Using the Real Time Monitor, take a few readings while the sensor is still in the standard. Be sure units are set to ppm. Readings should be very close to your selected concentration.

Redox (ORP) Channel Calibration

Note on units: The unit “Eh” refers to readings in millivolts referenced to a hydrogen electrode. In other words, Eh represents millivolt readings that would have been obtained if using a hydrogen electrode. The units “mV” are direct millivolt readings from the sensor.

— For Calibration You Will Need—

- A beaker or bucket of a sample that is representative of what will be measured with the sensor.
- An alternate redox meter.
- Distilled or deionized water.
- Paper towels.

— Computing Calibration Value—

Note: When calibrating a redox channel, do not use the built-in calculator in the Field Calibration Window. Instead, follow the instructions below.

1. Rinse sensor with distilled or deionized water, and then pat dry with clean paper towels.
2. Place the sensor in sample. (Solution must be deep enough to cover the sensing bulb.)
3. Using the alternate meter, take a measurement of that sample. Use either plain mV or Eh, whichever you normally use.
4. In Aqua4Plus - set display units to either mV or Eh, whichever you used for the above step.
5. Scan for and click on the sensor.
6. Open the field calibration window (*Configure | Field Calibration*).
7. Click on the redox (ORP) channel, and then enter a zero in the offset box.
8. Click **OK**
9. Take two or three single readings using the Real Time monitor and note the redox value.
10. Subtract this value from the value read in the step 3.

— Applying Calibration Value—

11. Open the field calibration window.
12. Click on the redox channel, and then enter this value in the offset box.
13. Click **OK**.

— Verifying Calibration Values—

14. Take another couple single Real Time readings. These should be close to the reading taken with the other meter.

Appendix B1: pH Field Calibration Temperature Chart

The pH of any buffer varies slightly with temperature change. For this reason, it is important that you determine the current pH value of the buffer you are using during calibration. From this chart, determine the pH value at your current buffer temperature and use this value as the “Ref pH” value in the field calibration window. For example, if you are using a pH buffer of 7 and your buffer temperature is 20 degrees C, then you would enter 7.02 in the Ref pH box.

Calibration Temperature		pH 4.00	pH 7.00	pH 10.00
°C	°F			
10	50	4.00	7.07	10.19
15	59	4.00	7.05	10.12
20	68	4.00	7.02	10.06
25	77	4.00	7.00	10.00
30	86	4.02	6.99	9.94
35	95	4.02	6.98	9.90
40	104	4.04	6.97	9.85
45	113	4.05	6.97	9.82
50	122	4.06	6.97	9.78

Appendix B2: M & I Range for pH Calibration

There are two variations of TempHion pH configuration. Depending on which way yours is configured, your M and I values should be between those values shown in the chart below when you calibrate the sensor.

To determine which configuration you have, you will need to create a short session, then upload and export the data – it doesn’t matter whether the sensor is deployed, or in a buffer, or just in air for this. Once you have exported your session, open it in Excel and note the P and H values for the pH channel.

Advanced Calibration Data								
Temperature	Cal Date	m	b	Thermistor	KOhm	A	B	C
pH/ISE/Redox	Cal Date	m	b	Type	Fill.Sol.	P/P/Offset	H	
Temperature	10/29/2012 12:11	1	0	30K5A -5 to 100	30	.009832175441	.000221287786	.000000126382
pH	10/29/2012 12:11	1	0	pH	INW reference	2.97	.567	
Redox	10/29/2012 12:11	1	0	Redox	INW reference	322.	.54	

If P = 2.97 and H = 0.567, this is the preferred configuration for all but the wastewater pH sensors.

If P = -2.389 and H = -0.29, this is an older configuration. This can still be used, but if you need higher accuracy, contact INW for instructions on how to reconfigure.

If P = 6.76 and H = 0.567, this is a wastewater pH sensor, without a reference solution reservoir.

Depending on which version you have, your M and I values during calibration of the pH channel should be in the following ranges.

	P = 2.97 H = 0.567	P = -2.389 H = -0.29	P = 6.76 H = 0.567
Range for M	-53 to -57	-50 to -60	-50 to -60
Range for I	240 to 270	180 to 300	180 to 300

Appendix C: Elements, Reference Solutions, and Related Settings

With the exception of our Wastewater pH unit, all TempHions need to have reference solution in the solution reservoir. (See the Maintenance section in this manual for details on care and filling of the reference solution reservoir.)

The following chart shows the reference solution that should be used with various elements. There are also specific settings that are set under Advanced Calibration. These are set at the factory to match your element and need not be changed by the user.

Element	Reference Solution	Isopotential Factor P	Temperature Factor H	Offset
pH	INW	2.97	0.567	--
Redox	INW	--	0.54	0
Chloride	ION-Plus B	3.572	0.49	--
Bromide	INW	3.878	0.89	--
Wastewater pH	None	6.76	0.567	--

Appendix D: How to Store and Recondition

When storing your TempHion, care must be taken to properly protect the electrodes, including the reference electrode. After storage, before use, the electrodes may need reconditioning, depending on the electrode and the mode of storage. INW's recommendations follow. If you have further questions, please contact your INW technical support representative.

Storage

Reference Electrode

- Best if stored in filling solution.
- Alternately, can be stored in KCl.
- If storing dry, be sure to empty and clean reservoir (see maintenance section earlier in this manual).

pH bulb / ORP

- Best if stored in pH 4 or KCl.
- Can be stored dry, but may shorten life of bulb. In INW's experience, the bulb should last roughly two years if typically stored dry.

ISE

- Storing dry is best.
-

Reconditioning

Reference Electrode

- If stored dry or in KCl, refill per maintenance section earlier in this manual. Once refilled, let sit for 30 minutes before using.
- If stored in reference solution, no reconditioning is needed.

pH bulb / ORP

- If stored dry, soak in 1st buffer for 4 hours before calibrating. (Must be calibrated before use.)
- If stored in KCl or pH 4, no reconditioning is needed.

ISE

- If stored dry, soak in 1st calibration solution for 30 minutes before calibrating. (Must be calibrated before use.)

Appendix E: Alternate Connection Options

Connecting via RS232 Serial Port

In its cabled configuration, the TempHion™ cable is terminated with a weather-resistant connector. In its cableless configuration, the TempHion™ is terminated with a weather-resistant connector inside a screw-cap. Connect the weather-resistant connector to your computer's serial port as shown below.

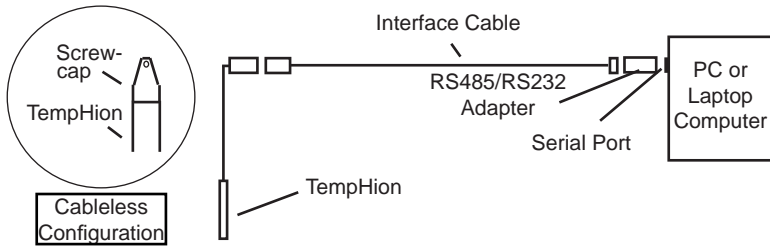

Connect the TempHion™ to your computer using an RS485/RS232 adapter and an interface cable.

Connecting with a USB/Serial Adapter

USB-to-Serial cables are readily available from many electronics and computer stores, as well as numerous sites on the Internet. INW has tested and recommends the Keyspan USA-19HS. It is available from INW as well as from many sites on the Internet. Install as follows:

- Plug into USB port.
- Install the drivers provided with the particular unit.
- Determine the port number to which the adapter is assigned.
 - Right-click on My Computer.
 - From the popup menu, select Manage to open the Computer Management window.
 - On left panel, click on Device Manager.
 - On right panel, double-click on Ports.
 - A list of active COM ports will be displayed. Note the COM number assigned to the adapter you just installed.
For example:  Keyspan USB Serial Port (COM4)
 - Close Manager.
- Connect to the sensor.
- On the Aqua4Plus software, select the COM port noted above. (If you do not see your new COM port in the dropdown box, open the Communications dialog box from the Options menu. Increase the Highest COM port number, up to a maximum of 15.)

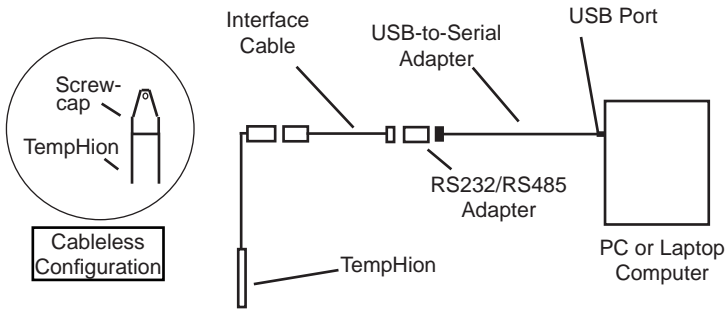

Connect the TempHion™ to your computer using a USB to Serial adapter and an interface cable.

Appendix F: Reading the TempHion™ via Direct Read

While the TempHion comes with INW's easy to use Aqua4Plus software, you can also use standard Modbus® RTU or SDI-12 equipment to easily take readings, so as to tie into your existing equipment or networks.

You may need to use Aqua4Plus to make a few settings, prior to directly reading the TempHion with your equipment. For one thing, you may want to change the units for returned values. If reading via Modbus, you may also need to set the baud rate. (You do not need to set the baud rate for SDI-12). These are described in the following sections.

For Modbus you must have TempHion firmware version 1.1 or higher. For SDI-12 you must have version 2.0 or higher.

Setting Units for Direct Read

The TempHion has up to four data channels. The first channel is always temperature. The Temperature channel, by default, uses degrees Celsius. If you want to change to different units, for example, degrees Fahrenheit, set these units using Aqua4Plus.

- Click on the Configure menu, and then select Advanced.
- From the flyout menu, select Direct Read Units. If you do not see this option, be sure your sensor is running the correct firmware.
- On the popup box, click the down-arrows next to Temperature, and then select the units you want.
- Click OK.

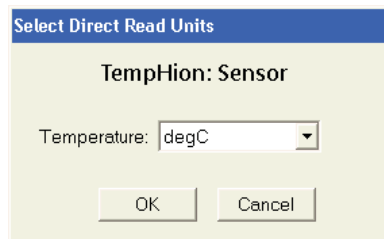

Use Aqua4Plus to select the units for your direct read measurements, whether Modbus or SDI-12

The remaining channels are mV channels and can be configured at the factory as pH, ISE, Redox, or ISE 3-Point channels. Each of the mV channels return two direct read values. The first is always mV. The second is either pH, ppm, or Eh, depending on the channel type.

Once set, these units are saved on the sensor and direct readings, either via Modbus or via SDI-12, will return values using these units. (Note: These settings do not affect the units used on the Aqua4Plus display. Refer to the Aqua4Plus software manual for details on using Aqua4Plus.)

Reading Via Modbus® RTU

Setting Baud Rate

Your TempHion comes configured to communicate at 38,400 baud, with 8 data bits, one stop bit, and no parity. The sensor can also be set to 19,200 or 9600 baud, if needed for your application.

If needed, set your TempHion to the desired baud rate as follows:

- Click on the Configure menu, and then select Advanced.
- From the flyout menu, select Sensor Baud Rate. (You may be asked for a password. Enter admin.)
- On the popup box, click the down-arrow and select the baud rate you need, and then click OK.

Once you have changed the baud rate on the TempHion, you will not be able to talk to it with Aqua4Plus until you change the baud rate for Aqua4Plus, as follows:

- Click the Options menu, and then select Baud Rate.
- On the popup box, click the down-arrow, select the baud rate you need, and then click OK.

The current Aqua4Plus baud rate is displayed in the lower right corner of the main Aqua4Plus window.

Taking Measurements

Reading Registers

Read measurements using Modbus function 03 – Read Holding Registers.

Readings are located in two registers each, starting at address 62592. (TempHion register addressing is zero based, i.e., starts at zero. If your equipment uses one based addressing, you will need to add one to the register addresses.)

Register Addresses for TempHion with Firmware 2.5 or higher		
To read:	Zero-Based	One-Based
Temperature	62592	62593
pH in pH units	62594	62595
ISE in ppm	62596	62597
ORP in Eh	62598	62599
pH in mV	62600	62601
ISE in mV	62602	62603
ORP in mV	62604	62605

Register Addresses for TempHion with Firmware Prior to 2.5

To read:	Zero-Based	One-Based
Temperature	62592	62593
pH in mV	62594	62595
ISE in mV	62596	62597
ORP in mV	62598	62599
pH in pH units	62600	62601
ISE in ppm	62602	62603
ORP in Eh	62604	62605

Measurement Timing

When you request a reading via Modbus, the sensor wakes up, returns the current values in the registers, and then starts taking new readings and updating the registers. After approximately 10 seconds, if no more readings have been requested, the sensor goes back to sleep.

Because of this, the first reading you get will be old. If you are taking readings at intervals of less than 10 seconds, simply ignore the first reading — all remaining readings will be current. On the other hand, if you are taking readings at intervals of greater than 10 seconds, take a reading, ignore it, wait one second, take another reading. Record this second reading.

Data Format

The data is returned as 32-bit IEEE floating-point values, high word first, also referred to as big-endian or float inverse.

For further information and detailed Modbus examples, see INW application note, “*Modbus Direct Read on Aquistar Smart Sensors*” available from our web site at www.inwusa.com/technical-library/application-notes.

Reading Via SDI-12

SDI-12 commands always return values for all four TempHion channels – temperature, pH, ISE, and ORP channels. Most TempHions are configured either as temperature, pH, and ISE or just temperature and ISE (such as Chloride or Bromide). You will need to disregard the readings for the channel(s) you do not have configured on your unit.

Note: The default units for temperature is Celsius. To change this, use the Direct Read Units option under the Configure | Advanced menu in the Aqua4Plus Control Software. When using the M!, MC!, C!, or CC! command, all mV channels will report in either pH, ppm, or Eh, depending on the channel type (pH = pH, ISE = ppm, Redox = Eh). When using the M1!, MC1!, C1!, or CC1! command, all mV channels will report in mV.

Addressing

Default SDI-12 Address: 0

SDI-12 Command Nomenclature

<a> = Sensor address

{crc} = SDI-12 compatible 3-character CRC

<cr> = ASCII carriage return character

<lf> = ASCII line feed character

highlighted values indicate variable data

SDI-12 Commands

/** Sensor Identification

```
<a>I! <a>13 INWUSA TempHi2.5sssssssss<cr><lf>
```

// note: **2.5** will change to reflect current

// firmware revision

// ssssssssss = device serial #

/** Acknowledge Active, Address Query

```
<a>! <a><cr><lf>
```

```
?! <a><cr><lf>
```

/** Change Address

```
<a>A<b>! <b><cr><lf>
```

// change address from <a> to

/** Request measurement

```
<a>M! <a>0024<cr><lf>
```

// request all measurements

```
<a>D0! <a>+21.345+7.181+.053+.459.431<cr><lf>
```

// read: Temperature, pH in pH units,

//ISE in ppm, ORP in Eh

```
<a>M1! <a>0024<cr><lf>
```

// request measurements

```
<a>D0! <a>+21.34-134.458+100.48+.84.404<cr><lf>
```

// read: Temperature, pH in mV, ISE in mV,

//ORP in mV

Note: For firmware version 2.0 – 2.3, the M! and M1! commands are swapped. Likewise for the MC!/MC1!, C!/C1!, and CC!/CC1! commands.

/** Request measurement with CRC

```
<a>MC! <a>0024<cr><lf> // request all measurements w/CRC
<a>D0! <a>+21.345+7.181+.053+.459.431{crc}<cr><lf>
// read: Temperature, pH in pH units,
//ISE in ppm, ORP in Eh
```

```
<a>MC1! <a>0024<cr><lf> // request measurements w/CRC
<a>D0! <a>+21.34-134.458+100.48+.84.404{crc}<cr><lf>
// read: Temperature, pH in mV, ISE in mV,
//ORP in mV
```

/** Concurrent measurement

```
<a>C! <a>00204<cr><lf> // request all measurements
<a>D0! <a>+21.345+7.181+.053+.459.431<cr><lf>
// read: Temperature, pH in pH units,
//ISE in ppm, ORP in Eh
```

```
<a>C1! <a>00204<cr><lf> // request measurements
<a>D0! <a>+21.34-134.458+100.48+.84.404<cr><lf>
// read: Temperature, pH in mV, ISE in mV,
//ORP in mV
```

/** Concurrent measurement with CRC

```
<a>CC! <a>00204<cr><lf> // request all measurements w/CRC
<a>D0! <a>+21.345+7.181+.053+.459.431{crc}<cr><lf>
// read: Temperature, pH in pH units,
//ISE in ppm, ORP in Eh
```

```
<a>CC1! <a>00204<cr><lf> // request measurements w/CRC
<a>D0! <a>+21.34-134.458+100.48+.84.404{crc}<cr><lf>
// read: Temperature, pH in mV, ISE in mV,
//ORP in mV
```

For further information and SDI-12 examples, see the INW application note, “*TempHion Interface Specification (SDI-12)*” available from our web site at www.inwusa.com/technical-library.

Appendix G: Battery Changing Details

Battery Type: Two standard AA Alkaline batteries.

Because changing the batteries involves opening the water-tight seal, **this must be done in a clean, dry environment to avoid contamination or moisture damage to the circuitry.**

Tips

- Never place a tool on the sensor body, it is very thin and will deform causing leaks at o-ring seals and potentially crushing the circuit board!
- Always twist the sensor body off the top cap assembly rather than twisting the top cap assembly off of the sensor body.
- For cabled sensors, always clamp the sensor on the swaged area when applicable, the shoulder above it will allow you to press down without the worry of the sensor slipping out of the clamping device.
- If the sensor body is slippery or you are unable to grip it hard enough to twist, try a piece of rubber cabinet liner for additional friction.

Opening the Housing

There is a black, compressible square ring near the top of the sensor. This ring acts as a spring to lock the cable in. This needs to be compressed in order to allow removal of the top cap. Once this ring is compressed, a gentle counterclockwise twist is all that is needed to remove the cable from the sensor body. Compressing the black square ring does take force, **twisting does not**.

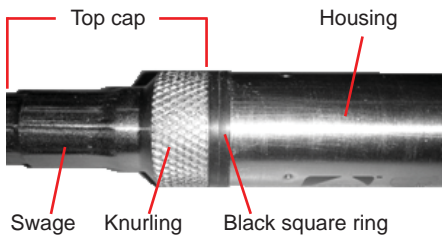

Cabled Sensor

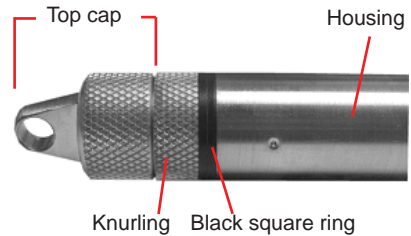

Cableless Sensor

Care must be taken to compress the black square ring before attempting to twist the housing. **Forceful twisting of the housing can permanently damage the sensor.**

Securing the sensor

In order to compress the black square ring, the sensor must be secured so that you can apply downward pressure to compress the ring. This can be done by holding in your hand, using a vise, or using pliers, as detailed below.

By Hand - cabled version only

1. Tightly grasp the top cap in one hand.
2. Brace your hand against something such as a table or the ground. (Do not allow the cable to be pinched against the brace.)

Continue to **Removing the Housing** on the next page.

With Vise - recommended method

Cabled Sensor

1. If possible, use a set of soft jaws as shown to prevent marring the surfaces of the top cap assembly.
2. Place the sensor in a vise clamping gently on the swaged area. You do not need to clamp the vise very hard.

Continue to **Removing the Housing** on the next page.



Cabled Sensor - gripping on swage

Cableless Sensor

1. If possible, use a set of soft jaws as shown to prevent marring the surfaces of the top cap assembly.
2. Remove the cableless top cap.
3. Place the sensor in a vise clamping gently on the knurled area. You do not need to clamp the vise very hard.

Continue to **Removing the Housing** on the next page.



Cableless Sensor - gripping on knurled area

With Pliers or Vise Grips - good for field use

Cabled Sensor

1. Grasp the pliers on the swaged area (do not grab the knurled diameter).
2. Find a hard edge and place the tips of the jaws of the pliers onto this edge as shown. This will allow you to press down with your weight to compress the square ring.

Continue to **Removing the Housing** below.

Cableless Sensor

1. Leave the cableless cap on in order to protect the pins inside.
2. Grasp the pliers on the knurled area tightly being careful to avoid grabbing the knurled cap.
3. Find a hard surface and place the cableless cap down onto it. This will allow you to press down with your weight to compress the square ring.

Continue to **Removing the Housing** below.



Cabled Sensor



Cableless Sensor

Removing the Housing

1. With your free hand, grasp the sensor body. Press down to compress the square ring. Twist gently. Once the body begins to twist, you can stop the compression action.
2. Finish gently twisting until the sensor body is removed.
3. Carefully disconnect the wiring connector inside from the circuit board in the top cap.

Replacing Batteries and Resealing Sensor

1. Gently pull wiring to one side in order to allow batteries to fall out. Shake gently if needed.
2. Replace batteries with button (+) facing open end.
3. Reinstall wiring connector — it only goes in one way, so make sure not to force it.



Pull wires gently to the side to allow battery removal.



Connector connected properly

4. Hold the top cap assembly at 90° to the housing opening as shown. Depress the spring with your fingertip and tuck the wiring into the cutaway on the circuit board with your thumb to protect it while being installed back into the housing.
5. Rotate the top cap assembly into the opening in the housing being very careful not to nick or pinch any wires.
6. Gently press down until the assembly stops and then twist it into place. It will click in and decompress the gasket when it is fully engaged.



Wires tucked into slot and spring tucked into housing.



Push top cap in before twisting and locking.



Properly completed — black ring uncompressed

Reordering Information

For sales & service offices, please contact:

INW
www.inwusa.com
800-776-9355

**LIMITED WARRANTY/DISCLAIMER -
AquiStar® TempHion™ Smart Sensor**

A. Seller warrants that products manufactured by Seller when properly installed, used and maintained, shall be free from defects in material and workmanship. Seller's obligation under this warranty shall be limited to replacing or repairing the part or parts or, at Seller's option, the products which prove defective in material or workmanship within ONE (1) year from the date of delivery, provided that Buyer gives Seller prompt notice of any defect or failure and satisfactory proof thereof. Any defective part or parts must be returned to Seller's factory or to an authorized service center for inspection. Buyer will prepay all freight charges to return any products to Seller's factory, or any other repair facility designated by Seller. Seller will deliver replacements for defective products to Buyer (ground freight prepaid) to the destination provided in the original order. Products returned to Seller for which Seller provides replacement under this warranty shall become the property of Seller.

This limited warranty does not apply to lack of performance caused by abrasive materials, corrosion due to aggressive fluids, mishandling or misapplication. Seller's obligations under this warranty shall not apply to any product which (a) is normally consumed in operation, or (b) has a normal life inherently shorter than the warranty period stated herein.

In the event that equipment is altered or repaired by the Buyer without prior written approval by the Seller, all warranties are void. Equipment and accessories not manufactured by the Seller are warranted only to the extent of and by the original manufacturer's warranty.

THE FOREGOING WARRANTIES ARE IN LIEU OF ALL OTHER WARRANTIES, WHETHER ORAL, WRITTEN, EXPRESSED, IMPLIED OR STATUTORY. IMPLIED WARRANTIES OF FITNESS AND MERCHANTABILITY SHALL NOT APPLY. SELLER'S WARRANTY OBLIGATIONS AND BUYER'S REMEDIES THEREUNDER (EXCEPT AS TO TITLE) ARE SOLELY AND EXCLUSIVELY AS STATED HEREIN. IN NO CASE WILL SELLER BE LIABLE FOR CONSEQUENTIAL DAMAGES, LABOR PERFORMED IN CONNECTION WITH REMOVAL AND REPLACEMENT OF THE SENSOR SYSTEM, LOSS OF PRODUCTION OR ANY OTHER LOSS INCURRED BECAUSE OF INTERRUPTION OF SERVICE. A NEW WARRANTY PERIOD SHALL NOT BE ESTABLISHED FOR REPAIRED OR REPLACED MATERIAL, PRODUCTS OR SUPPLIES. SUCH ITEMS SHALL REMAIN UNDER WARRANTY ONLY FOR THE REMAINDER OF THE WARRANTY PERIOD ON THE ORIGINAL MATERIALS, PRODUCTS OR SUPPLIES.

B. With respect to products purchased by consumers in the United States for personal use, the implied warranties including but not limited to the warranties of merchantability and fitness for a particular purpose, are limited to twelve (12) months from the date of delivery.

Some states do not allow limitations on the duration of an implied warranty, so the above limitation may not apply to you. Similarly, some states do not allow the exclusion or limitation of consequential damages, so the above limitation or exclusion may not apply to you. This limited warranty gives you specific legal rights; however, you may also have other rights which may vary from state to state.



©1997 - 2014 by Instrumentation Northwest, Inc. All rights reserved. Instrumentation Northwest and INW are trademarks registered with the U.S. Patent & Trademark Office. Doc# 9B0810r11 04/08/2014 / PN 6D279-NI



INW

8902 122nd Avenue NE
Kirkland, WA 98033 USA
425-822-4434

FAX 425-822-8384 / info@inwusa.com

1-800-PRO-WELL
WWW.INWUSA.COM

